

# Understanding Recharge to the Edwards Aquifer focusing on the Nueces River



Jenna Kromann

Fall 2013-CE 394K.3 GIS in Water Resources

## **Contents**

Introduction .....	3
Methods .....	7
Results .....	9
Conclusions .....	13
References .....	14
Appendix .....	15

## Introduction

Few studies exist in literature regarding karstic systems that quantify the interactions between the aquifer, stream, and alluvium. Multiple investigations have been conducted on the relation of rivers and alluvium channel beds (including hyporheic exchange), but very few investigate this where alluvium overlies a karst aquifer. It is important to understand the complex interactions of these systems because 25 percent of the world's population relies on karst aquifers for water supply (Ford and Williams, 2007). The Edwards Aquifer, a major aquifer of central Texas, is one of the largest karst aquifers in the United States (Loáiciga et al, 2000). Over 2 million people rely on the Edwards Aquifer for their primary source of water; many others use this water for irrigation of crops, land, or cattle (TWDB, 2012). The quantity of recharge into the Edwards Aquifer via surface water bodies may not be accurately quantified. Currently, mathematical models calculate recharge based on gauging station data (Puente, 1978). However, gauge density in the recharge zone of the Edwards Aquifer is limited, which may bias recharge estimates. Recharge into the aquifer is a key input parameter in groundwater models used for resource management. These models provide information that is applied to allocate the water resources in the Edwards Aquifer. The purpose of this project is to create an estimate of recharge into the Edwards Aquifer.

The area that is the focus of this study is the Nueces River as it crosses the recharge, and contributing zones of the Edwards Aquifer (Figure 1 and Figure 3). Recharge was estimated using python and the LDAS NDLAS land surface hydrology model. Rivers and streams in Uvalde County have low flow rates as they cross the aquifer recharge zone; this recharge enters the aquifer and flows to the Uvalde Pool of the Edwards Aquifer. Recharge from Uvalde County is approximately 45 percent of total recharge in the Edwards Aquifer (Clark, 2003). The available water for municipal use in the Edwards Aquifer is expected to decline between 2010 and 2060. In 2014, the South Central Texas Region will be in need of approximately 174,235 acre-ft. of water for agriculture and municipal use (TWDB, 2012). Understanding the aquifer and recharge inputs can aid in making effective and sustainable management decisions.

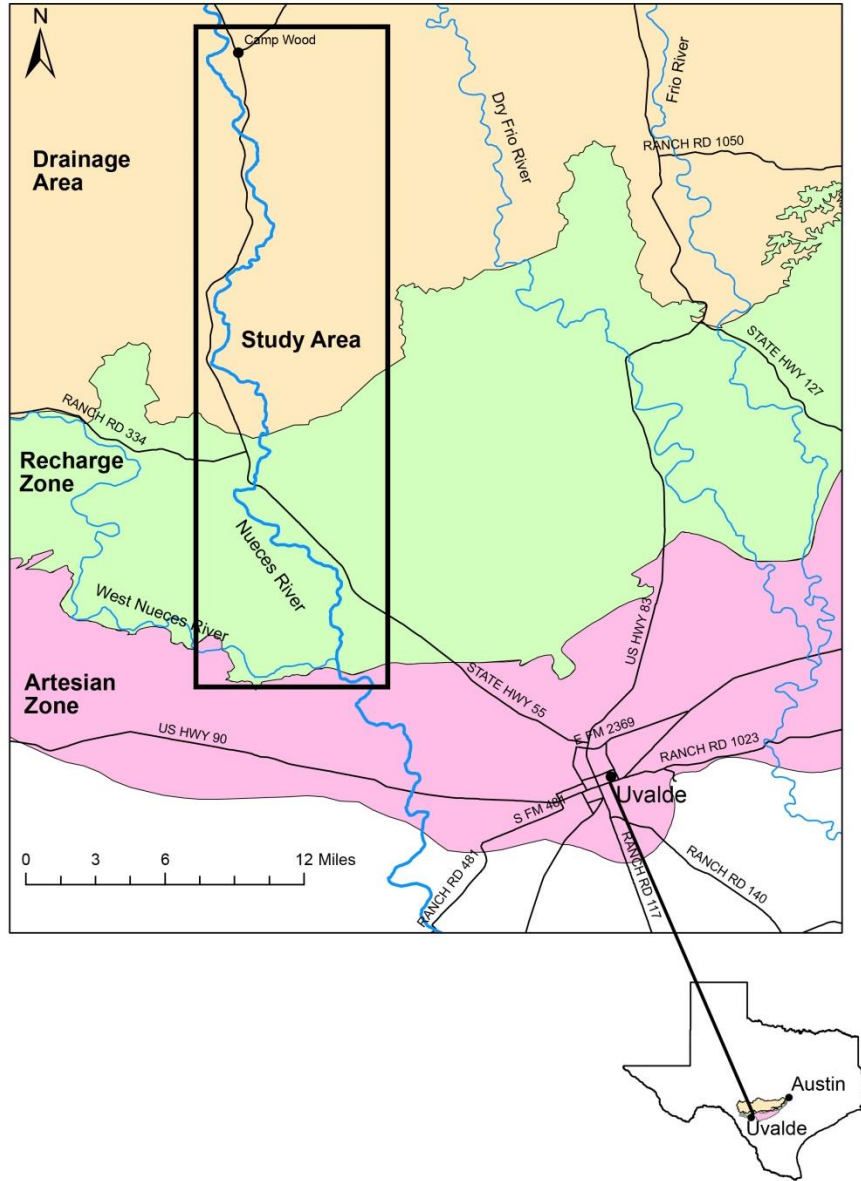
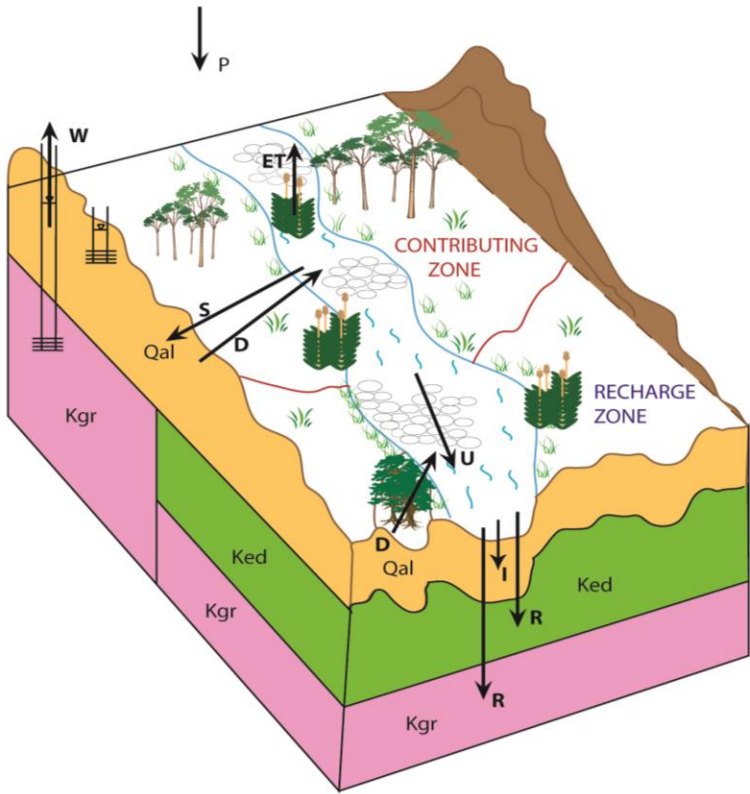

Figure 1. Overview of Study Area

### 3D Conceptual Model of the Water Cycle of the Nueces River



**Key**

- P-Precipitation
- ET-Evapotranspiration
- U-Underflow
- S-Storage
- R-Recharge
- I-Infiltration
- W-Pumping
- D-Discharge from bank storage, groundwater, surface water, or springs
- Qal-Quaternary Alluvium
- Kgr-Glen Rose Formation
- Ked-Edwards Group Limestone

Figure 2. Model of Water Balance in the Nueces River



# Nueces River Study Area

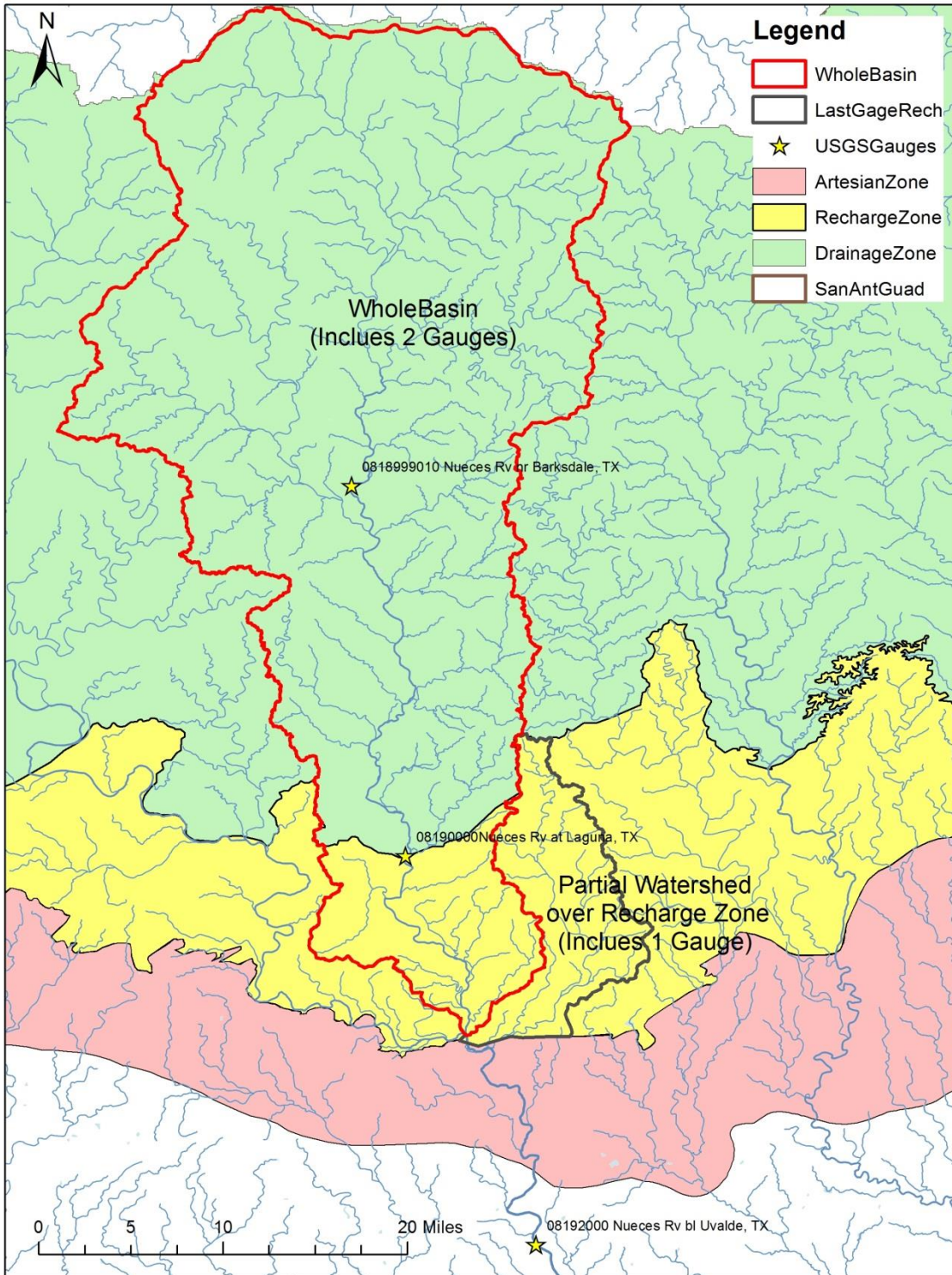

Figure 3. Watersheds of Study and Gauges of Study

## Methods

The recharge and water balance of the Nueces River Basin was analyzed based on a similar procedure that was used to do the GIS Class-Example 5. The data was collected from the United States Geological Survey (USGS) and from NASA. Data from NASA was collected from the Land Data Assimilation (LDAS NOAA) and land surface hydrology balance tool. This data collected from NLDAS was used to estimate the recharge from the Nueces River watersheds. Two different watersheds of the Nueces River over the Contributing and Recharge zones of the Edwards Aquifer were selected based on HUC8 watersheds downloaded from the USGS. These were chosen based on spatial location relative to stream gauges and location over the Contributing and Recharge zones of the Edwards Aquifer. Next, the temporal scale of study was chosen using yearly streamflow data from the Laguna Gauge on the Nueces River; four years of study were selected during high flow and low flow conditions. Data was gathered for the water years of 1980, 1997, 2007, and 2011 (Figure 4). The Laguna Gauge was selected because it had a long historical streamflow record and was located towards the middle of the study area. Once the watersheds were chosen, the data was downloaded from NLDAS NOAA model using a python script. After the data was downloaded and saved it was averaged spatially using another python script, this script output the data in a table that could be loaded into ArcGIS. The table was exported from ArcGIS and saved in excel. Then this data was analyzed using excel to calculate recharge. The following equation was used to calculate recharge based on the LDAS.

### Equation 1

*NLDAS Model*

$$P-ET-Runoff=Recharge$$

The next model that was used to estimate recharge was streamflow from three different gauges. These gauges cross over the contributing and the recharge zones of the Edwards Aquifer(Figure 3). This model was used to estimate recharge spatially over the Edwards Aquifer. These streamflow measurements provide physical measurements to compare to the modeled recharge estimates from the NDLAS Model. The following equation was used to calculate recharge based on gauges:

### Equation 1

*Stream Gauge Model*

$$Gauge\ Upstream-Gauge\ Downstream =Recharge$$

After the recharge was calculated for each of these models the data was analyzed.

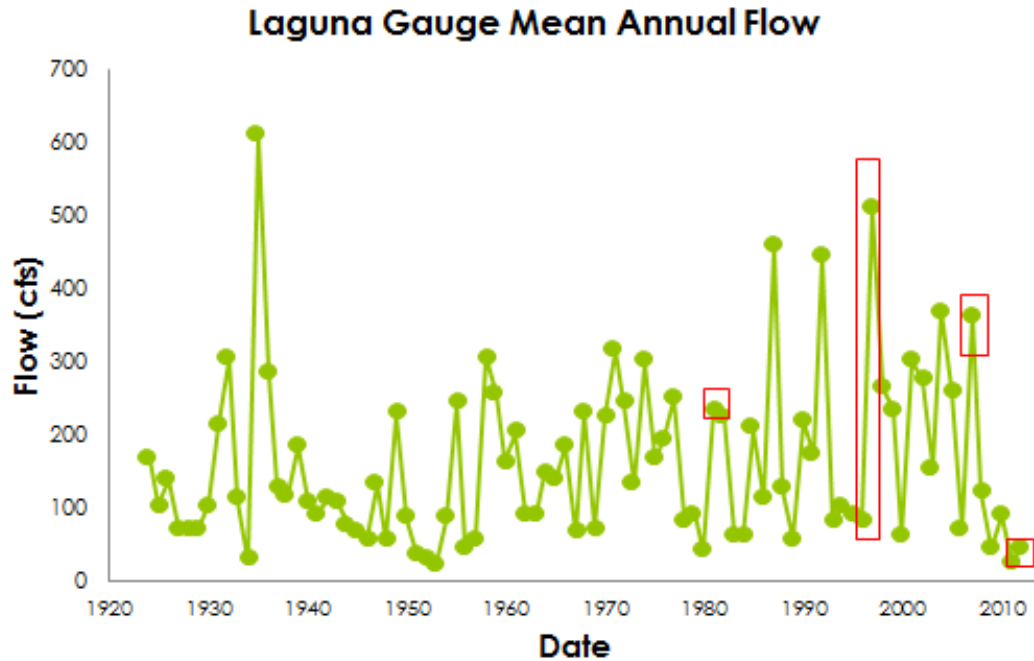

Figure 4. Flow at Laguna Gauge to show years picked in red boxes

The following years were selected to show different flow conditions:

Transition from Low to High Conditions: 1997-510.5cfs

High Flow Conditions: 2007-369.7cfs

Midlevel Flow Conditions: 1980-41.4cfs

Low Flow (very low, intense drought) Conditions: 2011-24.1cfs

The variables that were gathered from the NDLAS model were: precipitation (RF), surface runoff (Qsurf), subsurface runoff (Qbase), soil moisture (SM), and plant canopy surface (Cstor) in  $\text{kg}/\text{m}^2$ . Below is a figure that shows the surface balance estimated from the NDLAS (Figure 5).

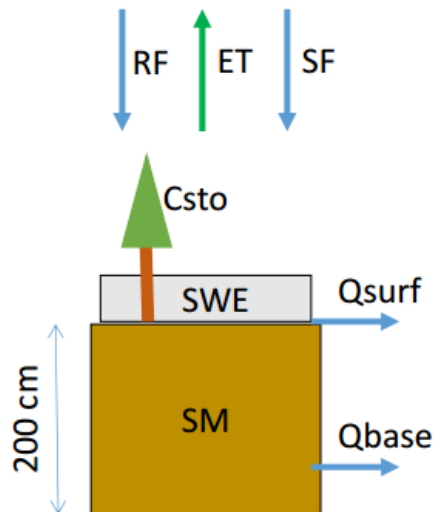

Figure 5. Water balance of NDLAS (Tarboton and Madiment, 2013)



## Results

Results from calculating recharge using the NDLAS and stream gauge models are shown below (Figure 6, Figure 7, Figure 8, Figure 9, and Appendix). Similar results were obtained for both watersheds in each model (Whole Basin and Last Gauge Rech, Figure 3). The parameters from the NDLAS model impacted the most by high or low flows was the soil moisture, especially during the drought of 2011 (Figure 6 and Figure 7). During the drought of 2011 soil moisture dropped significantly to almost  $200 \text{ kg/m}^2$ . The other parameters collected from the NDLAS model that changed somewhat due to dry or wet conditions was in 1997 and 1980 the rainfall increased significantly thereby increasing evapotranspiration (Figure 6 and Figure 7). After these parameters were collected from NASA's NDLAS model recharge was calculated based on Equation 1.

Based on the NDLAS model recharge increased during wet times or the transition from dry to wet. During 1980 there was a significant amount of recharge, as it was a wet year with increased precipitation. In the transition from wet to dry in 1997 recharge increased due to increased rainfall in July. During dry times in 2007 recharge only happened in one month when there was increased precipitation in July. There was significantly less recharge during the major drought of 2011, less than  $5 \text{ kg/m}^2$  (Figure 8 and Figure 9). Calculations of recharge using the NDLAS model parameters produced some negative recharge numbers. This could be an error in the model or assumptions made. It is difficult to model recharge in a semi-arid environment because minor changes in precipitation or evapotranspiration can significantly impact the amount of recharge modeled.

Recharge that was calculated using Equation 2, displayed an increased amount of recharge from the Nueces River as it crossed the Recharge Zone of the Edwards Aquifer. There was not a large amount of recharge that occurred as the Nueces River crossed the contributing zone, only during the drought of 2011 (Appendix, Table). This model was used to look at the spatial aspect and physical aspects of recharge in the aquifer.

Whole Basin Watershed (Nueces River)

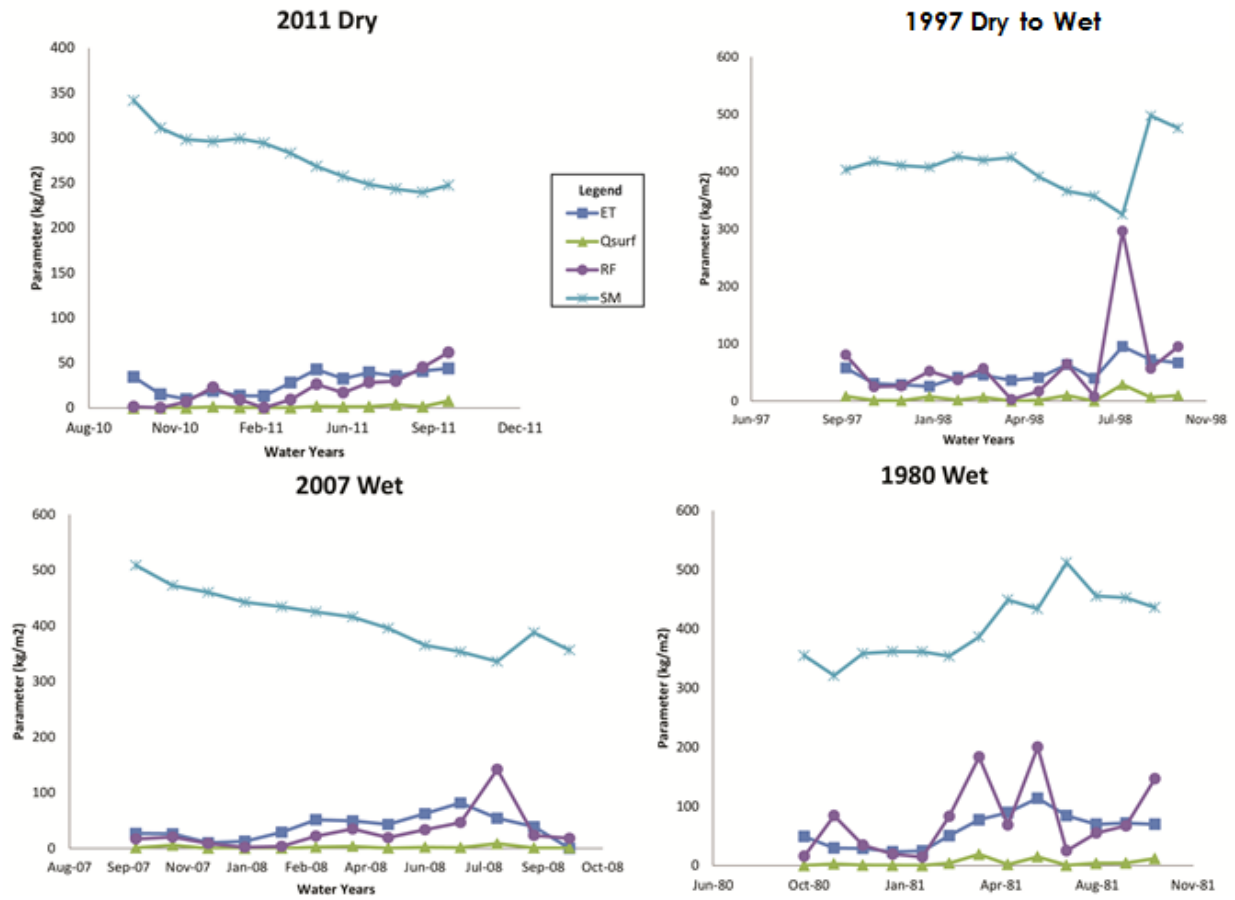

Figure 6. Whole Basin Watershed Results from NDLAS

Last Gauge Rech. Watershed (Nueces River)

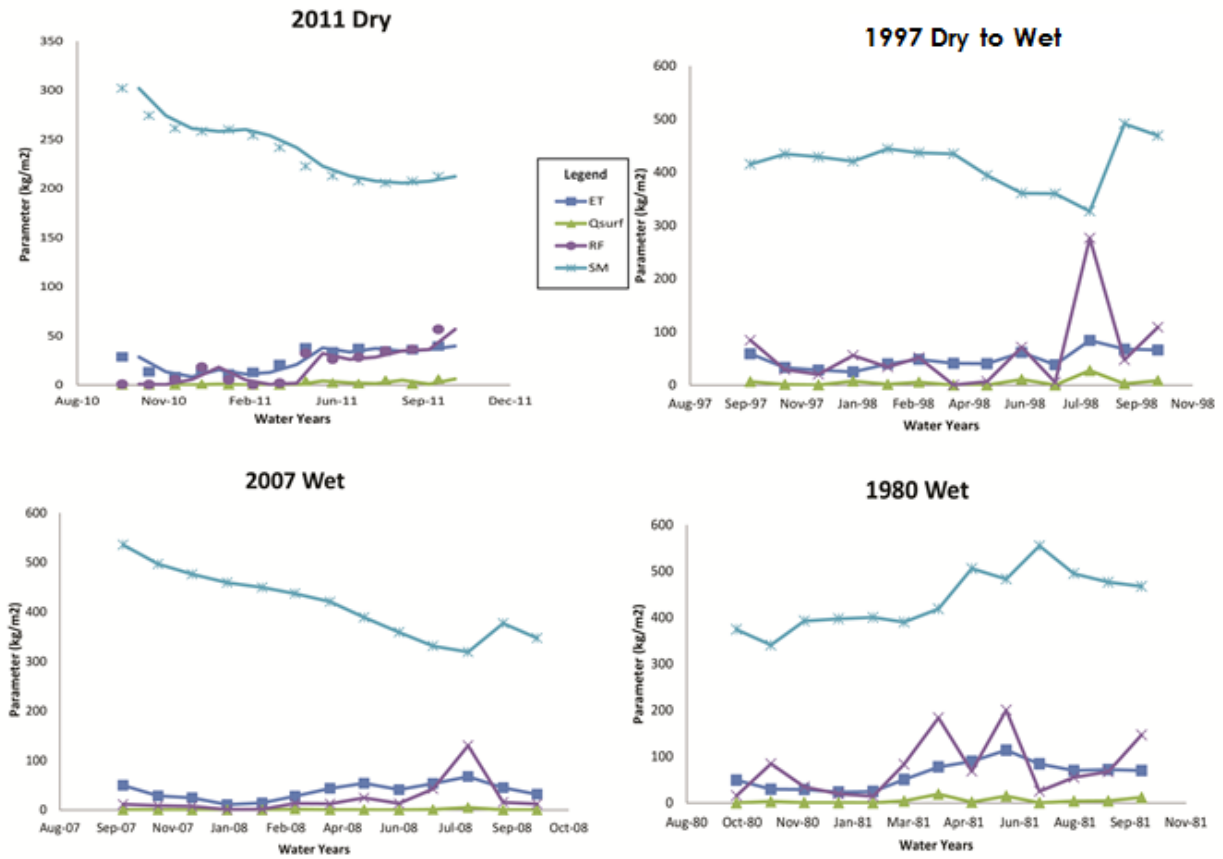

Figure 7. Last Gauge Recharge Zone Watershed NDLAS Results

Recharge Estimates (Whole Basin Watershed)

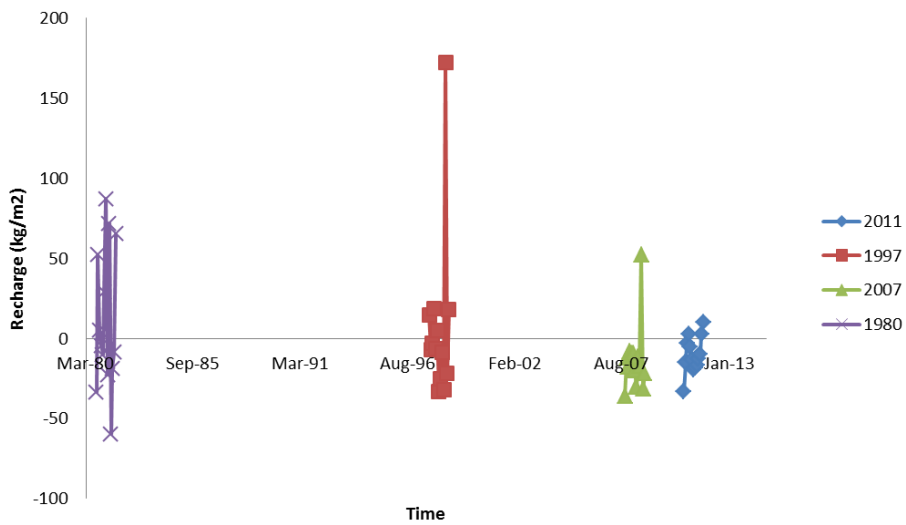

Figure 8. Recharge Estimates from Whole Basin Watershed NDLAS Results

### Recharge Estimates (Last Gauge Rech. Watershed)

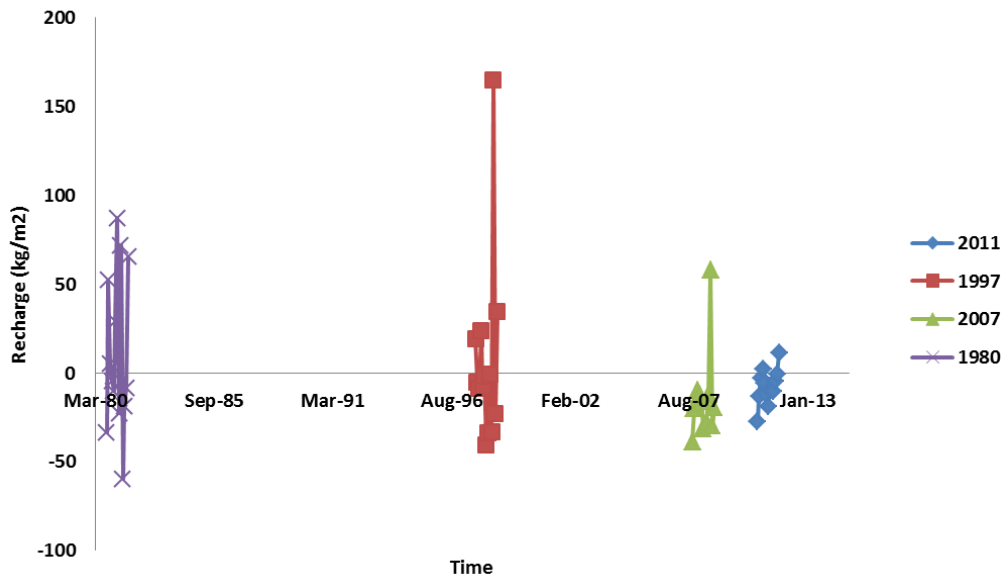

Figure 9. Recharge Estimates from Last Gauge Recharge Zone Watershed from NDLAS Results

## Conclusions

The two different models that were used showed that there is a significant amount of recharge from the Nueces River that could be recharging the Edwards Aquifer. In general, under dry conditions the Nueces River may not be recharging the Edwards Aquifer, especially during times of drought similar to the drought of 2011. During wet time periods when flow and precipitation are high recharge to the Edwards Aquifer is increased. Overall recharge seems to be occurring over the designated recharge zone of the Edwards Aquifer. The NDLAS was a good model to estimate recharge, although it had limitations. Recharge that was calculated using the NDLAS model was negative at times; this could be due to assumptions made about ET or precipitation. It is difficult to model recharge in semi-arid regions because different values about variables (ET, precipitation, or soil moisture) can greatly impact the model calculations. The NDLAS model may be too broad of a model to estimate recharge in these smaller watersheds. In the future this model could be improved by having a smaller scale and increasing the number of years analyzed for recharge. Overall this project was successful in determining that most recharge from the Nueces River is occurring over the designated recharge zone in the Edwards Aquifer and increased recharge happens during wet conditions.



## References

1. Clark, A.K., Edwards Aquifer Authority (Tex.), and Geological Survey (U.S.), 2003, Geologic framework and hydrogeologic characteristics of the Edwards aquifer, Uvalde County, Texas: U.S. Dept. of the Interior, U.S. Geological Survey ; U.S. Geological Survey Information Services [distributor], Austin, Tex. : Denver, CO.
2. Ford, D.C., and Williams, P., 2007, Karst Hydrogeology and Geomorphology: Wiley, Chichester.
3. Green, P., Bertetti, P., and McGinnis, R., 2009, Investigating the Secondary Aquifers of the Uvalde County Underground Water Conservation District Final Report: Geosciences and Engineering Division Southwest Research Institute, p. 1-74.
4. Hamilton, J.M., Johnson, S., Mireles, J., Esquilin, R., Burgoon, C., Luevan, G., Gregory, D., Gloyd, R., Sterzenback, J., and Mendoza, R., 2008, Edwards Aquifer Authority Hydrologic Data Report for 2007: Edwards Aquifer Authority.
5. Loáiciga, H.A., Maidment, D.R., and Valdes, J.B., 2000, Climate-change impacts in a regional karst aquifer, Texas, USA: *Journal of Hydrology*, v. 227, no. 1–4, p. 173–194, doi: 10.1016/S0022-1694(99)00179-1.
6. Puente, C., 1978, Method of estimating natural recharge to the Edwards aquifer in the San Antonio area, Texas: U.S. Geological Survey Water-Resources Investigations Report, 78-10.
7. D., Tarboton and D., Maidment, 2013, Example 5-ArcGIS Fall 2013
8. <http://www.edwardsaquifer.org/aquifer-data-and-maps/gis>
9. <http://www.usgs.gov/water/>
10. <http://water.usgs.gov/GIS/huc.html>

## Appendix

### Python Code:

#### Downloads data from NOAA NLDAS modified from David Tarboton

```
# -----  
# Downloads.py  
# Created on: 2013-10-27  
# David Tarboton  
# Description:  
# This script automates the repetitive downloads of NLDAS data over a watershed  
# The toolbox location needs to be edited for your system  
# The file Downloads.csv needs to be edited to control the variables to download  
# -----  
  
# Import arcpy module  
import arcpy, datetime, os  
from arcpy import env  
  
# Inputs -----  
gdbname=r"NuecesBasin.gdb" # geodatabase  
zones=r"NewTwoGageRech" # Name of zone (basins) feature class in geodatabase  
infile=r"Downloads.csv"  
# End of inputs -----  
  
# Load the LDAS toolbox. Adjust this line to where it occurs in your system  
arcpy.ImportToolbox(r"C:\Users\Jenna\Documents\ArcGIS\Packages\LDAStools\v101\applicati  
on\LDAS tools.tbx")  
  
# Local variables:  
# Use the current working directory as the folder  
Folder=os.getcwd() # or r"D:\Scratch\Ex5"  
env.workspace = Folder  
print Folder  
Basin = Folder+os.sep+gdbname+os.sep+zones  
print Basin  
Outfold=Folder+os.sep+"2011\NewTwoGageRech"  
# If this folder does not exist make it  
if not os.path.isdir(Outfold):  
    os.makedirs(Outfold)  
print Outfold  
f=open(infile)  
line=f.readline() # reads the header  
for line in f:
```

```

cols=line.split(",")
Outfolder=Outfold+os.sep+cols[0]
if not os.path.isdir(Outfolder):
    os.makedirs(Outfolder)
Dataset=cols[1]
Var=cols[2]
Begdate=cols[3]
Enddate=cols[4]
print Basin
arcpy.LDASNOAHdownloader(Basin, Dataset,Var, Outfolder, Begdate, Enddate)

```

### All Zonal Averages from NOAA NLDAS modified from David Tarboton

```

# Python modules used
import sys
import arcpy, datetime, os, shutil
from arcpy import env
from arcpy.sa import *

# Inputs -----
gdbname="NuecesBasin.gdb" # geodatabase
zones=r"NewLastGageRech" # Name of zone (basins) feature class in geodatabase
outtable="zwork6"
# End of inputs -----

# Check out the ArcGIS Spatial Analyst extension for using the zonal statistics function
arcpy.CheckOutExtension("spatial")

# Use the current working directory as the folder to work in
Folder=os.getcwd() # or r"D:\Scratch\Ex5"
env.workspace = Folder

# Full file paths
zonestype=gdbname + os.sep + zones # Basin feature class
WorkFolder = Folder+os.sep+"new1980" # This is the folder used for input data
TempFolder = Folder+os.sep+"temp" # This is the folder where temporary tables are written
if not os.path.isdir(TempFolder):
    os.makedirs(TempFolder)
VarFolders=os.listdir(WorkFolder)
tabnamefull=gdbname+os.sep+outtable
field1="Vrcode"
field2="Date"
field3="Value"
field4="TimeSupport"

```

```

arcpy.CreateTable_management(gdbname, outtable,"","") # Create Table
arcpy.AddField_management(tabnamefull, field1,"TEXT","","","","") # Add code field
arcpy.AddField_management(tabnamefull, field2, "DATE","","","","") # Add date field
arcpy.AddField_management(tabnamefull, field3,"FLOAT","","","","") # Add value field
arcpy.AddField_management(tabnamefull, field4, "TEXT","","","","") # Add support field
rows = arcpy.InsertCursor(tabnamefull,"")

```

```

for VarFolder in VarFolders:

```

```

    VarFiles=os.listdir(WorkFolder+os.sep+VarFolder)

```

```

    for theFile in VarFiles:

```

```

        if theFile.endswith(".asc"): # Only ASC files

```

```

            if(theFile[-6:-4]=="00"): # This occurs for an hourly file

```

```

                dateString = theFile[-15:-7]

```

```

                timeSupport="Hour"

```

```

            else:

```

```

                dateString = theFile[-10:-4]

```

```

                timeSupport="Month"

```

```

            #print VarFolder + " " + theFile + " " + dateString

```

```

            zonetable=TempFolder + os.sep +VarFolder+ dateString # to keep unique name

```

```

            fullFile=WorkFolder+os.sep+VarFolder+os.sep+theFile

```

```

            outZSaT = ZonalStatisticsAsTable(zoneshape, "OBJECTID", fullFile,
                zonetable, "", "MEAN")

```

```

            tableRow = arcpy.UpdateCursor(zonetable)

```

```

# zone table only has one row. Extract its mean

```

```

    for linerow in tableRow:

```

```

        meanValue = linerow.MEAN

```

```

    print VarFolder + " " + dateString + " " + str(meanValue)

```

```

    line = rows.newRow()

```

```

    if timeSupport=="Hour":

```

```

        date=datetime.datetime.strptime(dateString,'%Y%m%d')

```

```

    else:

```

```

        date=datetime.datetime.strptime(dateString,'%Y%m')

```

```

    line.setValue(field1,VarFolder)

```

```

    line.setValue(field2,date)

```

```

    line.setValue(field3,meanValue)

```

```

    line.setValue(field4,timeSupport)

```

```

    rows.insertRow(line)

```

```

# Clean up

```

```

del line

```

```

del rows

```

```

del linerow

```

```

del tableRow

```

# redo last zonal statistics. Append "t" to name to make it different. This seems necessary to delete the locks

```
outZSaT = ZonalStatisticsAsTable(zoneshape, "OBJECTID", fullFile,
                                zonetable+"t", "", "MEAN")
```

try:

```
if os.path.isdir(TempFolder): # Remove temporary folder
    shutil.rmtree(TempFolder)
```

except:

```
print "Unable to delete temporary folder: "+TempFolder
print "Done"
```

**Table of Recharge Calculations:**

RECHARGE CONTRIBUTING ZONE (cfs)												
	Jan	Feb	Mar	Apr	May	Jun	Jul	Aug	Sep	Oct	Nov	Dec
<b>1980</b>	30.4	14.7	21.5	11.9	32.2	3	-4.3	5.3	22.7	41.5	24.1	28
<b>1981</b>	27.2	8.6	61.4	397.9	230.3	1077	283.1	179.2	178.7	1190	260.7	165.1
<b>1997</b>	146.1	135.1	240.4	218.7	148.7	2227	393.5	176.7	104.8	103.6	77.7	64.7
<b>1998</b>	65.8	71.7	110.2	81.3	29	9.6	2.5	1609	615.8	482.8	356.2	230
<b>2007</b>	45.7	25.6	321.3	232.9	670.9	407	957	678.8	554.5	296	208.7	164.1
<b>2008</b>	122.1	80	72.3	56.8	41.3	11.5	11.8	39.3	47.1	30.7	26.5	24.9
<b>2010</b>	32.5	124	70.3	159.9	113.8	47.8	78.8	35.5	30.8	19.1	9.1	5.4
<b>2011</b>	8.4	-3.9	4.8	-4.7	-12.3	-21	-15.76	-2.3	-6	-2.6	-6.9	-4.8

RECHARGE ZONE (cfs)												
	Jan	Feb	Mar	Apr	May	Jun	Jul	Aug	Sep	Oct	Nov	Dec
<b>1980</b>	-43.9	-31.2	-29.2	-27.1	-48.7	-17	-5	-11.38	-28.1	-46.6	-31.9	-39.8
<b>1981</b>	99.7	-34.8	-78.7	-420.93	258.7	-922.3	1361.9	96.7	-59.5	-1080.8	2293.3	75.9
<b>1997</b>	-122.4	-94.1	-207.1	-57.4	45.7	-2129.5	2848.5	181.5	16	-54.5	-25.7	-31.3
<b>1998</b>	173.6	-69	-100.3	-63.8	-13.1	-12.7	-6.2	-1610.9	3425.2	181.8	171.5	129.8
<b>2007</b>	62.5	-53.6	-340.2	-141.6	-593.7	59.6	-633.7	778.2	48.8	160.9	35.7	-11.5
<b>2008</b>	-132.8	-22.5	-21.2	-24.9	-25.3	-10.8	-12.2	-35.5	-44.6	-31.6	-30.6	-33.2
<b>2010</b>	-50.56	-157.86	-92.6	-186.45	-137.93	-72.19	-90.4	-40.1	-39.08	-29.88	-22.08	-21.65
<b>2011</b>	-31.86	-28.96	-28.73	-23.14	-16.52	-10.55	-6.11	-12.09	-9.815	-16.382	-12.902	-17.306



**Example of Results Collected from NDLAS mode with Python Script**

Varcodes	Date	Value	TimeSupport
Cstor	10/1/2010	0.00	Hour
Cstor	11/1/2010	0.00	Hour
Cstor	12/1/2010	0.00	Hour
Cstor	1/1/2011	0.00	Hour
Cstor	2/1/2011	0.00	Hour
Cstor	3/1/2011	0.00	Hour
Cstor	4/1/2011	0.00	Hour
Cstor	5/1/2011	0.00	Hour
Cstor	6/1/2011	0.00	Hour
Cstor	7/1/2011	0.00	Hour
Cstor	8/1/2011	0.00	Hour
Cstor	9/1/2011	0.00	Hour
Cstor	10/1/2011	0.00	Hour
ET	10/1/2010	28.50	Month
ET	11/1/2010	13.47	Month
ET	12/1/2010	8.42	Month
ET	1/1/2011	15.38	Month
ET	2/1/2011	11.10	Month
ET	3/1/2011	12.80	Month
ET	4/1/2011	20.77	Month
ET	5/1/2011	37.76	Month
ET	6/1/2011	33.65	Month
ET	7/1/2011	37.13	Month
ET	8/1/2011	34.48	Month
ET	9/1/2011	35.93	Month
ET	10/1/2011	39.53	Month
Qbase	10/1/2010	0.00	Month
Qbase	11/1/2010	0.00	Month
Qbase	12/1/2010	0.00	Month
Qbase	1/1/2011	0.00	Month
Qbase	2/1/2011	0.00	Month
Qbase	3/1/2011	0.00	Month
Qbase	4/1/2011	0.00	Month
Qbase	5/1/2011	0.00	Month
Qbase	6/1/2011	0.00	Month
Qbase	7/1/2011	0.00	Month
Qbase	8/1/2011	0.00	Month
Qbase	9/1/2011	0.00	Month
Qbase	10/1/2011	0.00	Month

Qsurf	10/1/2010	0.00	Month
Qsurf	11/1/2010	0.00	Month
Qsurf	12/1/2010	0.07	Month
Qsurf	1/1/2011	0.88	Month
Qsurf	2/1/2011	0.18	Month
Qsurf	3/1/2011	0.00	Month
Qsurf	4/1/2011	0.01	Month
Qsurf	5/1/2011	4.16	Month
Qsurf	6/1/2011	2.20	Month
Qsurf	7/1/2011	1.38	Month
Qsurf	8/1/2011	4.91	Month
Qsurf	9/1/2011	0.85	Month
Qsurf	10/1/2011	6.07	Month
RF	10/1/2010	0.76	Month
RF	11/1/2010	0.49	Month
RF	12/1/2010	5.45	Month
RF	1/1/2011	18.18	Month
RF	2/1/2011	5.16	Month
RF	3/1/2011	0.51	Month
RF	4/1/2011	1.83	Month
RF	5/1/2011	32.09	Month
RF	6/1/2011	26.13	Month
RF	7/1/2011	28.29	Month
RF	8/1/2011	34.76	Month
RF	9/1/2011	36.13	Month
RF	10/1/2011	56.61	Month
SM	10/1/2010	301.95	Hour
SM	11/1/2010	274.20	Hour
SM	12/1/2010	261.21	Hour
SM	1/1/2011	258.17	Hour
SM	2/1/2011	260.09	Hour
SM	3/1/2011	253.97	Hour
SM	4/1/2011	241.68	Hour
SM	5/1/2011	222.74	Hour
SM	6/1/2011	212.91	Hour
SM	7/1/2011	207.56	Hour
SM	8/1/2011	205.61	Hour
SM	9/1/2011	207.41	Hour
SM	10/1/2011	212.25	Hour